

# Switches

## Standard CTI Switches

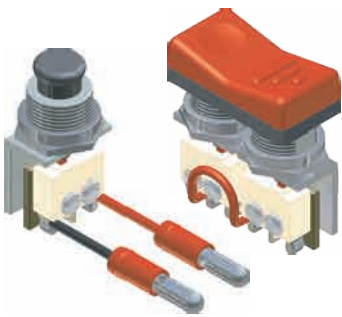

### CTI Rocker Switches

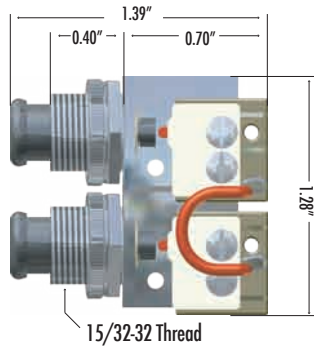
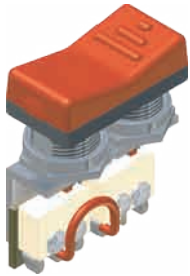

#### Circuit Diagram

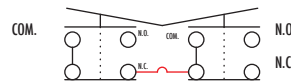

#### Panel Cutout Dimensions

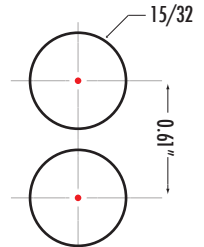

CTI Part # **32-R-922190-01** SPDT - mom (On)-Off-(On)

#### Technical Data

Cycles: **10,000,000**  
 Current Rating: **5 amps@120 vAC, 30vDC**  
 Temperature Range: **-55°C to +85°C @ Rated Current**  
 Internal Seals: **N/A**

Spring Rate: **6.9 lbs**  
 Environmental Protection: **IP40, IP67**  
 Wire Leads: **None**  
 Terminals: **None**

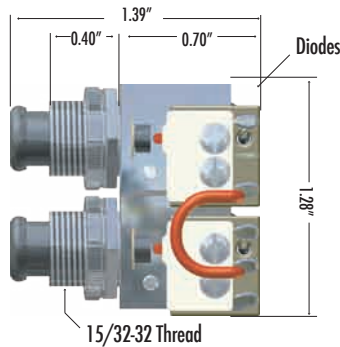
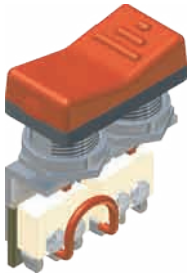

#### Circuit Diagram

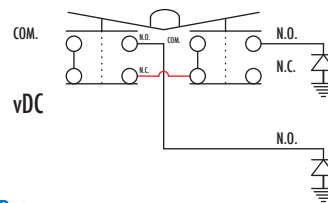

#### Panel Cutout Dimensions

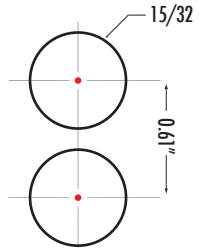

CTI Part # **32-R-922195-01** SPDT - mom (DC) (On)-Off-(On)

#### Technical Data

Cycles: **10,000,000**  
 Current Rating: **5 amps@30vDC**  
 Temperature Range: **-55°C to +85°C @ Rated Current**  
 Internal Seals: **N/A**

Spring Rate: **6.9 lbs**  
 Environmental Protection: **IP40, IP67**  
 Wire Leads: **None**  
 Terminals: **None**

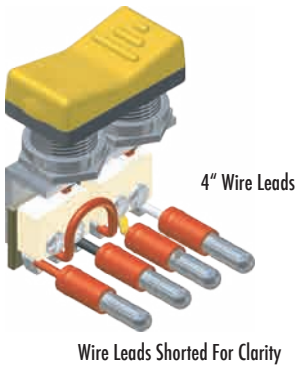

4" Wire Leads

Wire Leads Shorted For Clarity

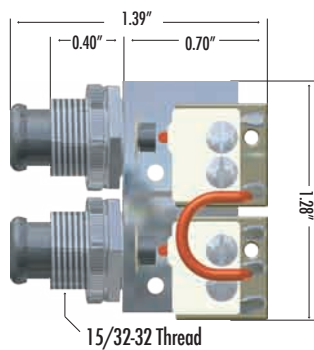

#### Circuit Diagram

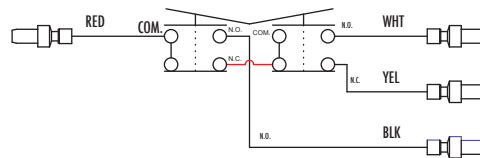

#### Panel Cutout Dimensions

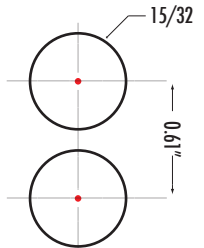

CTI Part # **32-R-960158-01** SPDT - mom (w/Cat-Leads) (On)-Off-(On)

#### Technical Data

Cycles: **10,000,000**  
 Current Rating: **5 amps@120 vAC, 30vDC**  
 Temperature Range: **-55°C to +85°C @ Rated Current**  
 Internal Seals: **N/A**

Spring Rate: **6.9 lbs**  
 Environmental Protection: **IP40, IP67**  
 Wire Leads: **4"**  
 Terminals: **Male Bullet 22-16, 0.156**

[www.cyber-tech.net](http://www.cyber-tech.net)

1-800-621-8754



# Switches

## Standard CTI Switches

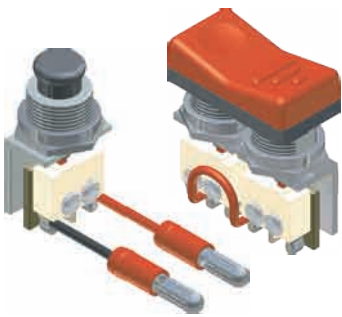

### CTI Rocker Switches

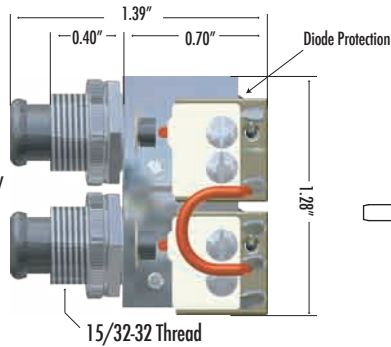
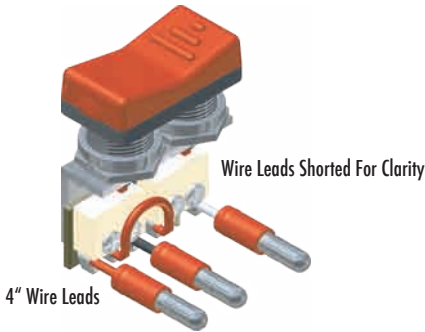

#### Circuit Diagram

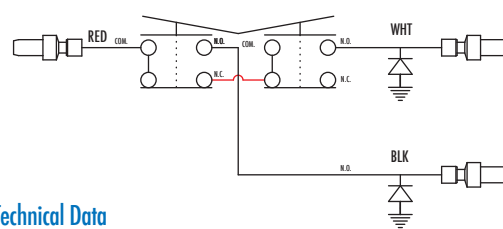

#### Panel Cutout Dimensions

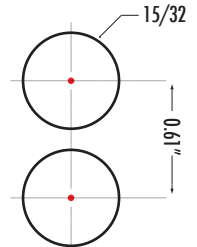

CTI Part # **32-R-920901-01** SPDT-MOM (DC w/leads) (On)-Off-(On)

#### Technical Data

Cycles: **10,000,000**  
 Current Rating: **5 amps@30VDC**  
 Temperature Range: **-40°C to +85°C @ Rated Current**  
 Internal Seals: **N/A**

Spring Rate: **6.9 lbs**  
 Environmental Protection: **IP40, IP67**  
 Wire Leads: **None**  
 Terminals: **None**

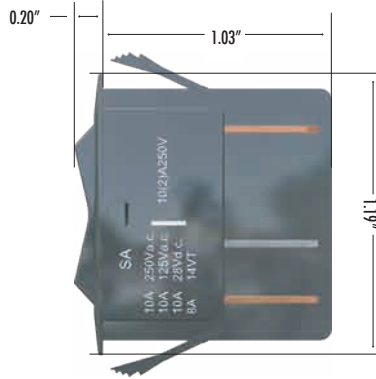

#### Circuit Diagram

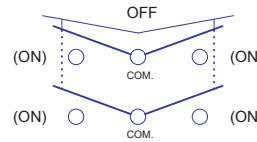

#### Panel Cutout Dimensions

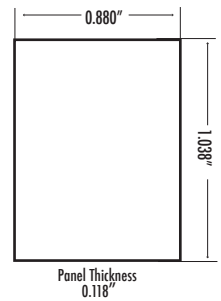

CTI Part # **32-R-2606-11E** DPDT mom (3-Position) (On)-Off-(On)

#### Technical Data

Cycles: **50,000**  
 Current Rating: **10 amps@28VDC**  
 Current Rating: **10 amps@125VAC, 10 amps@250VAC**  
 Temperature Range: **-40°C to +85°C @ Rated Current**

Terminals: **0.25\" Quick-Connect**

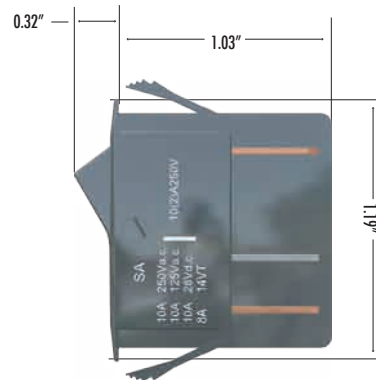

#### Circuit Diagram

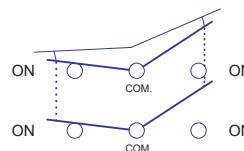

#### Panel Cutout Dimensions

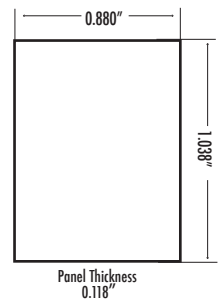

CTI Part # **32-R-2602-11E** DPDT mt (2-Position) On-None-On

#### Technical Data

Cycles: **50,000**  
 Current Rating: **10 amps@28VDC**  
 Current Rating: **10 amps@125VAC, 10 amps@250VAC**  
 Temperature Range: **-40°C to +85°C @ Rated Current**

Terminals: **0.25\" Quick-Connect**

[www.cyber-tech.net](http://www.cyber-tech.net)

1-800-621-8754



# Switches

## Standard CTI Switches

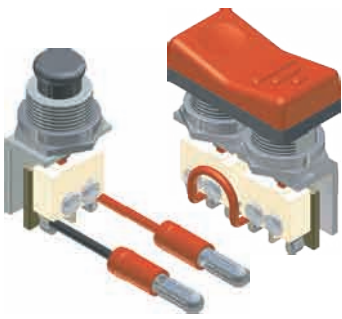

### CTI Rocker Switches

#### Circuit Diagram

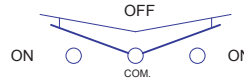

#### Panel Cutout Dimensions

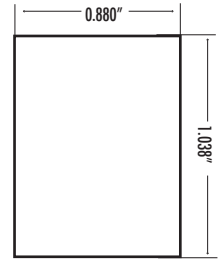

Panel Thickness  
0.118"

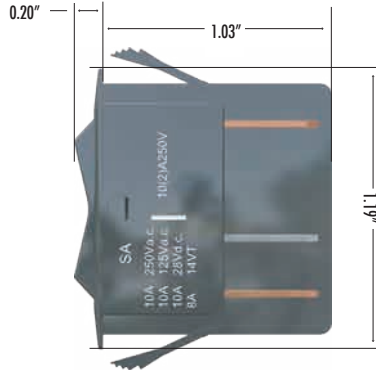

CTI Part # **32-R-2604-11E** DPDT mt (3-Postion) On-Off-On

#### Technical Data

Cycles: 50,000  
Current Rating: 10 amps@28vDC  
Current Rating: 10 amps@125vAC, 10 amps@250vAC  
Temperature Range: -40°C to +85° @ Rated Current

Terminals: 0.25" Quick-Connect

#### Circuit Diagram

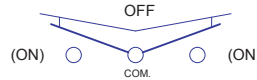

#### Panel Cutout Dimensions

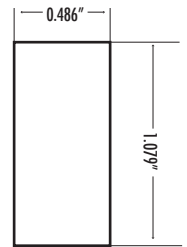

Panel Thickness  
0.118"

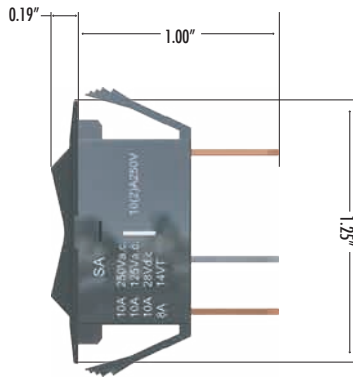

CTI Part # **32-R-1506-11E** SPDT mom (3-Postion) (On)-Off-(On)

#### Technical Data

Cycles: 50,000  
Current Rating: 10 amps@28vDC  
Current Rating: 10 amps@125vAC, 10 amps@250vAC  
Temperature Range: -40°C to +85° @ Rated Current

Terminals: 0.25" Quick-Connect

#### Circuit Diagram



#### Panel Cutout Dimensions

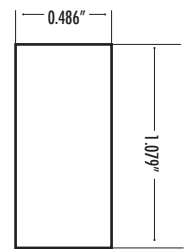

Panel Thickness  
0.118"

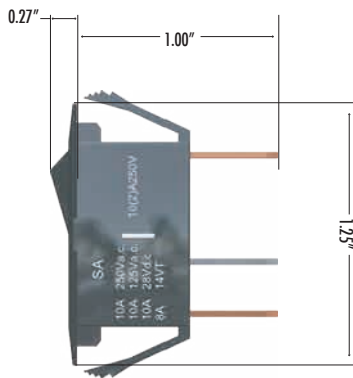

CTI Part # **32-R-1500-11E** SPDT mt (2-Postion) On-None-On

#### Technical Data

Cycles: 50,000  
Current Rating: 10 amps@28vDC  
Current Rating: 10 amps@125vAC, 10 amps@250vAC  
Temperature Range: -40°C to +85° @ Rated Current

Terminals: 0.25" Quick-Connect

[www.cyber-tech.net](http://www.cyber-tech.net)

1-800-621-8754



# Switches

## Standard CTI Switches

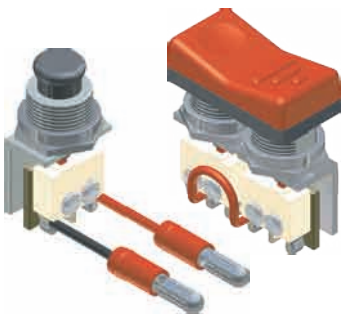

### CTI Rocker Switches

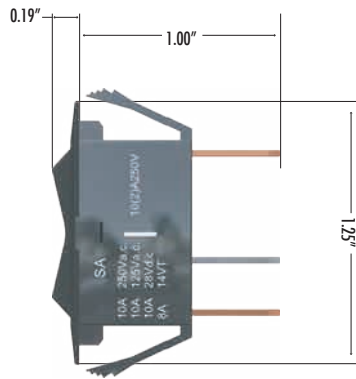

#### Circuit Diagram

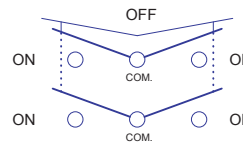

#### Panel Cutout Dimensions

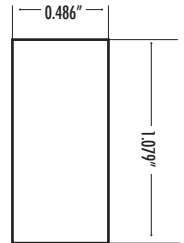

Panel Thickness  
0.118"

CTI Part # **32-R-1504-11E** SPDT mt (3-Position) (On)-Off-(On)

#### Technical Data

Cycles: 50,000  
Current Rating: 10 amps@28vDC  
Current Rating: 10 amps@125vAC, 10 amps@ 250vAC  
Temperature Range: -40°C to +85° @ Rated Current

Terminals: 0.25" Quick-Connect

[www.cyber-tech.net](http://www.cyber-tech.net)

1-800-621-8754

Document Date: 06-01-2005

"a commitment to intergrated engineering & design"

Image & Specifications Are Subject To Change Without Notice

Made in USA



# Switches Accessories

## CTI Rockers

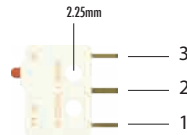
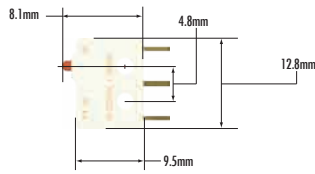

### Circuit Diagram

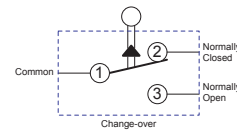

### Technical Data

Cycles: 10,000,000  
 Current Rating: 5 amps@120 vAC, 30vDC  
 Temperature Range: -40°C to +85° @ Rated Current  
 Spring Rate: .312 Lbs  
 Terminals: 2.0 mm  
 Package Size: F4

CTI Part # **32-S-F4T7**

SPDT - mom (5 amp Micro)

Referenced Dimensions Are In (mm)

Black Seal Cap



CTI Part # **76-010197-01**

Dusk Seal Cap

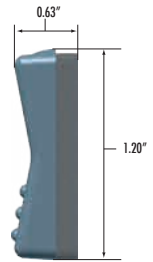

CTI Part # **76-010312-01**

Gray Seal Cap

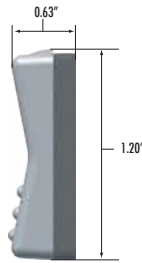

CTI Part # **76-010316-01**

Marigold Seal Cap

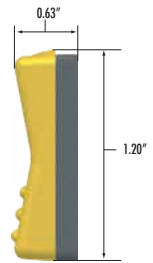
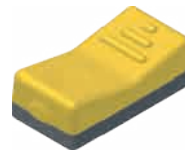

CTI Part # **76-950043-01**

Red Seal Cap

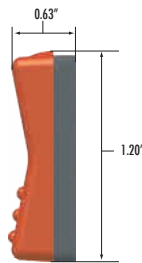
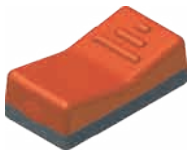

CTI Part # **76-010235-01**

Lock Washer

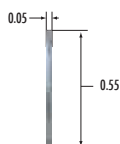

CTI Part # **99-W-1/2-L-S**

Hex Nut

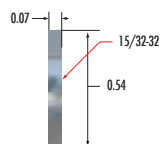

CTI Part # **99-N-15/32-32**

Knurl Nut

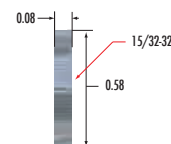

CTI Part # **99-N-15/32-32-RK**

Made in USA

